

BOROFLOAT® 33 – Mechanical Properties

The sum of its properties is what makes it unique

BOROFLOAT® 33 from Germany is the world's first floated borosilicate flat glass. It combines superior quality and excellent flatness with outstanding thermal, optical, chemical and mechanical features. The chemical composition and physical values of BOROFLOAT® 33 are in accordance with ASTM E 438-92 (2001), Type 1, class A. Rediscover BOROFLOAT® 33 and experience the infinite potential of our most versatile material platform.

BOROFLOAT® 33 – Inspiration through Quality.



Sight glasses and transparent, lightweight cover glasses require a maximum mechanical strength.

Key benefits:

Excellent mechanical strength

- Low weight
- Strong resistance to abrasion and scratches
- High elasticity

Mechanical properties

Density ρ (25° C)	2.23 g/cm ³
Young's Modulus E (according to DIN 13316)	64 kN/mm ²
Poisson's Ratio μ (according to DIN 13316)	0.2
Knoop Hardness HK _{0,1/20} (according to DIN ISO 9385)	480

Mechanical strength

The **bending strength** σ_b of BOROFLOAT® 33 with a

- typical float glass surface is normally 150 MPa*. Higher values are possible.
- surface pre-damaged to simulate used condition, is ~ 25 MPa**.

The strength of glass is not a material constant, but is subject to a statistical distribution according to the type and distribution of surface defects and depends, among other things, on the following criteria:

- Conditions during glass processing (including edge processing, drilled holes, etc.)
- Used condition of the glass surface
- Force, type and duration of the effective load
- Environmental conditions (e.g.: corrosive chemicals)
- The geometry of the glass pane and accompanying installation factors

* typical value determined in accordance with DIN EN ISO 1288-5; glass thickness 2.75 mm

** Pre-damaged with 220 sandpaper; based on the former DIN 52292 Part 1

When specifying data for the mechanical strength of glass, the special properties of this brittle material must be taken into account. When glass comes into contact with materials that are just as hard or harder, surface defects in the form of indentations and cracks occur. When glass is subjected to a mechanical load, the build-up of critical stress at the points of these indentations and cracks cannot be relieved by plastic flow, as is possible with ductile materials such as metals. Glass breaks without warning, whereby the material failure can occur over a relatively wide load area.

When using glass as a construction material (e.g. in mechanical and plant engineering), the respective country- and industry-specific requirements and standards must be observed for any material suitability test as well as the basis for any construction calculations.

All values listed on the data sheet are not guaranteed reference values.

Behaviour when glass surface is exposed to typical mechanical loads

Vickers-Test

Mechanical resistance to penetration by a pointed object –
BOROFLOAT® 33 is particularly resistant due to its glass structure.

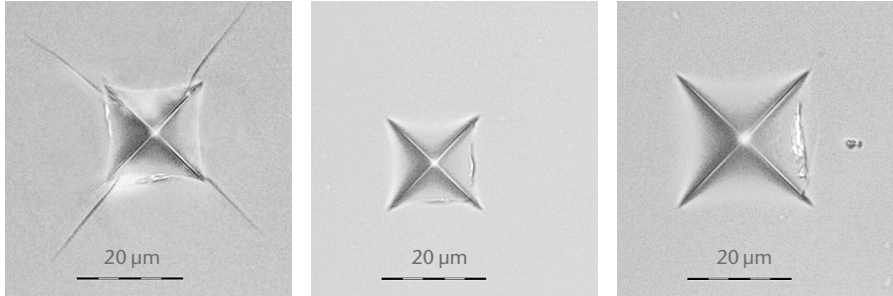

Soda-lime glass – 2 N

BOROFLOAT® 33 – 2 N

BOROFLOAT® 33 – 4 N

Scotch-Brite® – Abrasion Test:

Sliding abrasion (bound grain) – **BOROFLOAT® 33 shows much lower abrasion.**

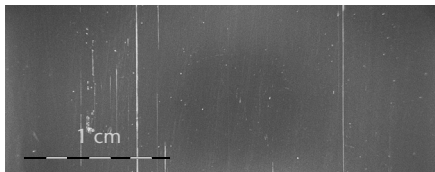

Soda-lime glass

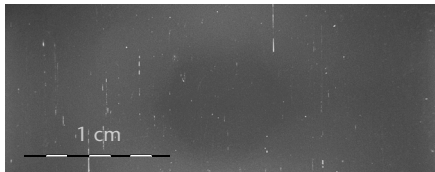

BOROFLOAT® 33

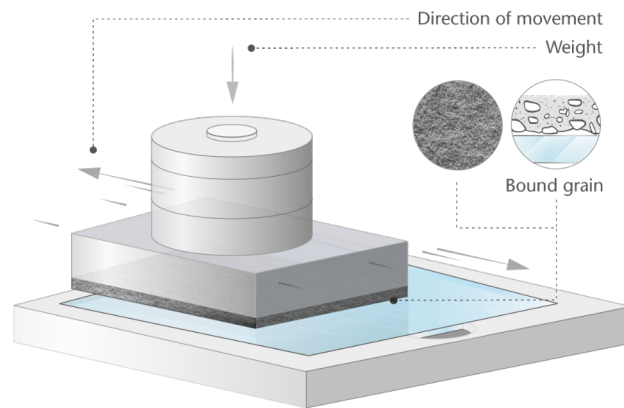

PEI Abrasion Test

Transition from sliding abrasion to erosion (grain fill, loose grains) – **BOROFLOAT® 33 is particularly abrasion resistant.**

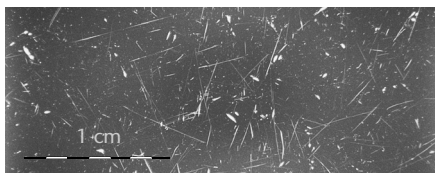

Soda-lime glass

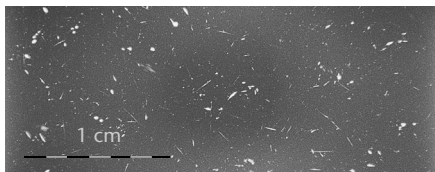

BOROFLOAT® 33

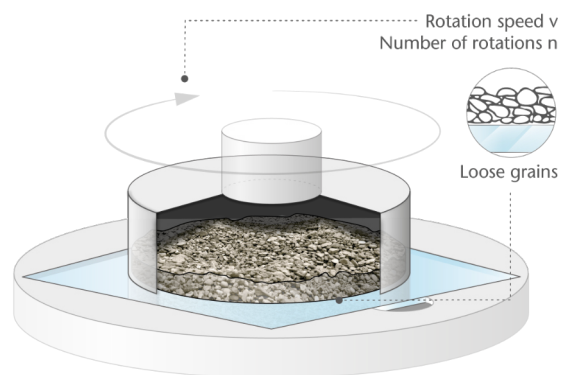

Scratch Resistance Test

Mechanical resistance to penetration by a scratching object – BOROFLOAT® is particularly scratch resistant.

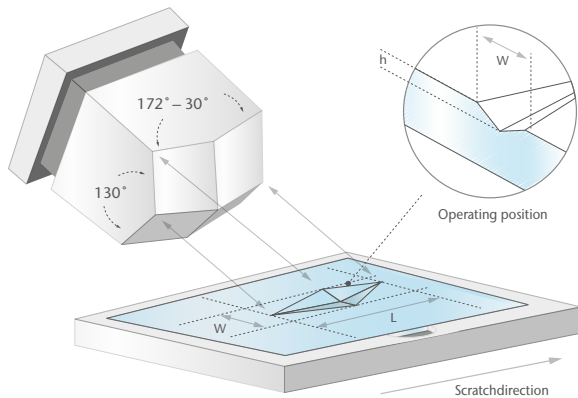

To damage the sample surface, a Knoop diamond is scratched over the sample along its long side with a constant normal force F_n

Microscope images of the scratches on BOROFLOAT®

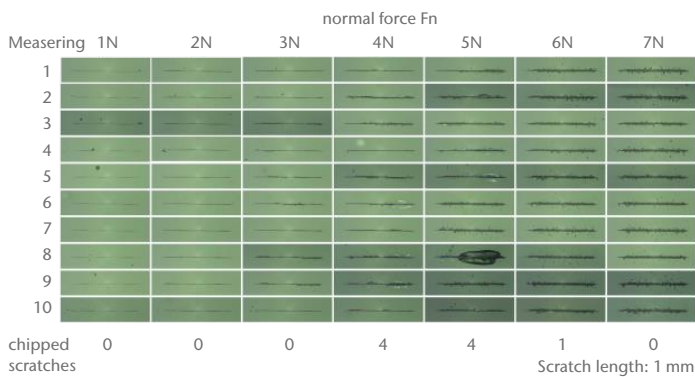

BOROFLOAT® has a significantly higher scratch resistance than soda-lime glass

Microscope images of the scratches on soda-lime glass

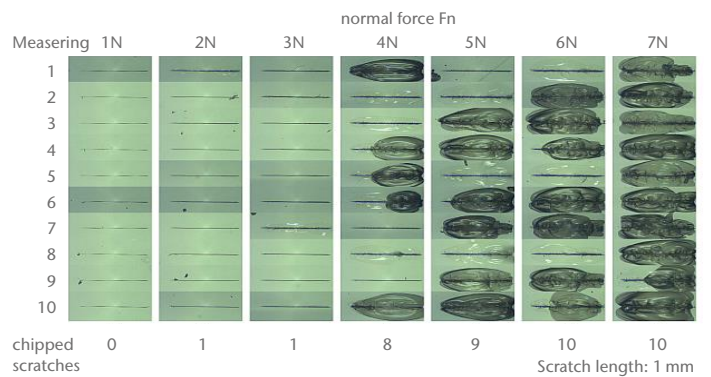

Stone impact tests according to DIN EN ISO 20567

Mechanical resistance to falling stones on the glass – BOROFLOAT® is highly impact resistant.

BOROFLOAT® 33 *

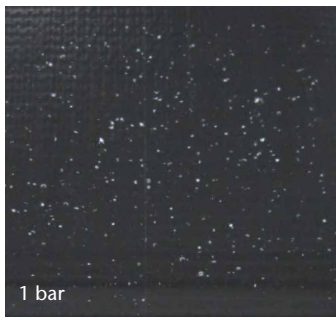

Damaged surface area 2.5 %

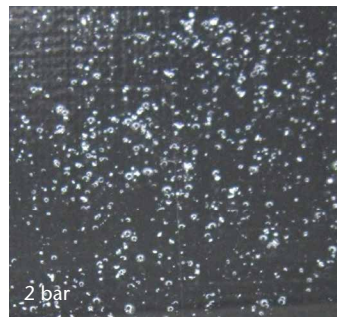

Damaged surface area 5.5 – 10.7 %

Soda-lime glass *

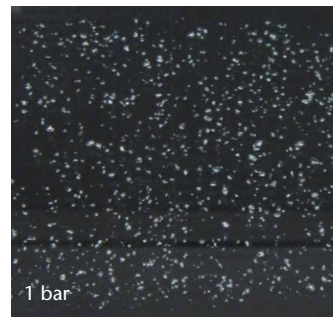

Damaged surface area 10.7 %

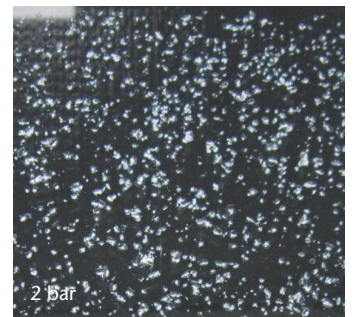

Damaged surface area 19.2 %

BOROFLOAT® shows a significantly higher resistance against stone impact than soda-lime glass.

*Image section app. 75 mm x 75 mm

Home Tech SCHOTT North America, Inc.
5530 Shepherdsville Road
Louisville, KY 40228, USA
Phone +1 (502) 657-44 17
Fax +1 (502) 966-49 76

borofloat@us.schott.com
www.us.schott.com/borofloat

SCHOTT
glass made of ideas